

Doble efecto  
 Ø 32 ... 200 mm

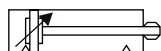
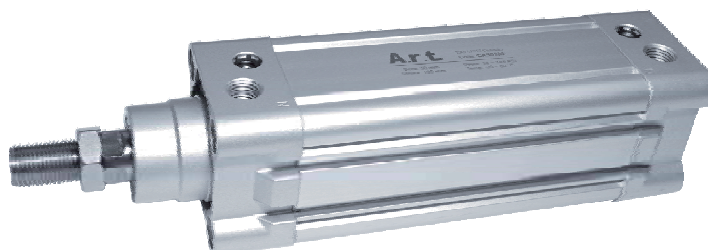

## Características

- Normas: ISO 15552  
 ISO 6431  
 VDMA 24562
- Modelos con embolo magnético para control de posición
- Los interruptores magnéticos quedan integrados en el perfil
- Los cilindros de 160 y 200 mm poseen sensores ocultos, camisa tipo mickey mouse
- Amortiguación regulable en ambas cabezas
- No requieren lubricación

## Modelos Standard

### Datos Técnicos

**Fluido:**  
 Aire comprimido Filtrado,  
 lubricado o no lubricado

**Presión de Trabajo:**  
 1 a 10 Bar ~ 14,5 a 145 PSI

**Temperatura de Trabajo:**  
 -20°C a 80°C ~ -4°F a 176°F

**Kit de Alta Temperatura:**  
 Hasta 150°C ~ 302°F

**Amortiguación:**  
 Neumática, Regulable

### Materiales

**Perfil:**  
 Aluminio inyectado

**Cabezas:**  
 Aluminio inyectado

**Vástago:**  
 Acero al carbón con 20µ de  
 superficie cromo-endurecida  
 Opcional: Acero Inoxidable

**Empaques:**  
 TPU (Poliuretano Termoplástico)  
 NBR

Carrera mm (Pulg)	Diametro del cilindro en milímetros								
	32	40	50	63	80	100	125	160	200
25 (1")	CA32025	CA40025	CA50025	CA63025	CA80025	CA100025	CA125025X	CA160025X	CA200025X
50 (2")	CA32050	CA40050	CA50050	CA63050	CA80050	CA100050	CA125050X	CA160050X	CA200050X
75 (3")	CA32075	CA40075	CA50075	CA63075	CA80075	CA100075	CA125075X	CA160075X	CA200075X
100 (4")	CA32100	CA40100	CA50100	CA63100	CA80100	CA100100	CA125100X	CA160100X	CA200100X
125 (5")	CA32125	CA40125	CA50125	CA63125	CA80125	CA100125	CA125125X	CA160125X	CA200125X
150 (6")	CA32150	CA40150	CA50150	CA63150	CA80150	CA100150	CA125150X	CA160150X	CA200150X
175 (7")	CA32175	CA40175	CA50175	CA63175	CA80175	CA100175	CA125175X	CA160175X	CA200175X
200 (8")	CA32200	CA40200	CA50200	CA63200	CA80200	CA100200	CA125200X	CA160200X	CA200200X
250 (10")	CA32250	CA40250	CA50250	CA63250	CA80250	CA100250	CA125250X	CA160250X	CA200250X
300 (12")	CA32300	CA40300	CA50300	CA63300	CA80300	CA100300	CA125300X	CA160300X	CA200300X
350 (14")	CA32350	CA40350	CA50350	CA63350	CA80350	CA100350	CA125350X	CA160350X	CA200350X
400 (16")	CA32400	CA40400	CA50400	CA63400	CA80400	CA100400	CA125400X	CA160400X	CA200400X
450 (18")	CA32450	CA40450	CA50450	CA63450	CA80450	CA100450	CA125450X	CA160450X	CA200450X
500 (20")	CA32500	CA40500	CA50500	CA63500	CA80500	CA100500	CA125500X	CA160500X	CA200500X
600 (24")	CA32600	CA40600	CA50600	CA63600	CA80600	CA100600	CA125600X	CA160600X	CA200600X
700 (28")	CA32700	CA40700	CA50700	CA63700	CA80700	CA100700	CA125700X	CA160700X	CA200700X
800 (32")	CA32800	CA40800	CA50800	CA63800	CA80800	CA100800	CA125800X	CA160800X	CA200800X
900 (36")	CA32900	CA40900	CA50900	CA63900	CA80900	CA100900	CA125900X	CA160900X	CA200900X
1000 (40")	CA321000	CA401000	CA501000	CA631000	CA801000	CA1001000	CA1251000X	CA1601000X	CA2001000X
1100 (44")							CA1251100X	CA1601100X	CA2001100X
1200 (48")							CA1251200X	CA1601200X	CA2001200X
1300 (52")							CA1251300X	CA1601300X	CA2001300X
1400 (56")							CA1251400X	CA1601400X	CA2001400X
1500 (60")							CA1251500X	CA1601500X	CA2001500X
Ø Vástago	12 mm	16 mm	20 mm	20 mm	25 mm	25 mm	32 mm	40 mm	40 mm
Conexión	G1/8	G1/4	G1/4	G3/8	G3/8	G1/2	G1/2	G3/4	G3/4
Empaques	CAK032	CAK040	CAK050	CAK063	CAK080	CAK100	CAK125	CAK160	CAK200
Alta Temp.	CAKA032	CAKA040	CAKA050	CAKA063	CAKA080	CAKA100	CAKA125	CAKA160	

\* Para carreras no standard y cilindros de doble vástago consulte con su distribuidor

Ø	CAP - Pies	CAF - Flanche	CAPP - Pivote Hembra	CAPM - Pivote Macho	CASM - Soporte Macho
---	------------	---------------	----------------------	---------------------	----------------------

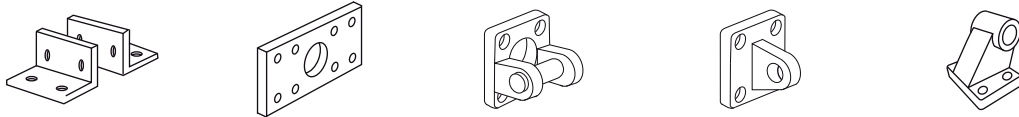

Ø	Referencia	Referencia	Referencia	Referencia	Referencia
32	CAP032	CAF032	CAPP032	CAPM032	CASM032
40	CAP040	CAF040	CAPP040	CAPM040	CASM040
50	CAP050	CAF050	CAPP050	CAPM050	CASM050
63	CAP063	CAF063	CAPP063	CAPM063	CASM063
80	CAP080	CAF080	CAPP080	CAPM080	CASM080
100	CAP100	CAF100	CAPP100	CAPM100	CASM100
125	CAP125	CAF125	CAPP125	CAPM125	CASM125
160	CAP160	CAF160	CAPP160	CAPM160	CASM160
200	CAP200	CAF200	CAPP200	CAPM200	CASM200

Ø	CAB - Balancín Frontal	CAH - Horquilla	CAR - Rotula	CAU - Autoalineador	CAAS - Soporte Sensor
---	------------------------	-----------------	--------------	---------------------	-----------------------



Ø	Referencia	Referencia	Referencia	Referencia	Referencia
32	CAB032	CAH032	CAR032	CAU032	
40	CAB040	CAH040	CAR040	CAU040	
50	CAB050	CAH063	CAR063	CAU063	
63	CAB063	CAH063	CAR063	CAU063	
80	CAB080	CAH100	CAR100	CAU100	
100	CAB100	CAH100	CAR100	CAU100	
125	CAB125	CAH125			
160	CAB160	CAH160			CAAS160
200	CAB200	CAH160			CAAS200

Sensores Magnéticos

Tipo Red Switch

**CASS01**

(Para Cil. 32 ~ 125 mm)



**CAASS01**

(Para Cil. 160 y 200 mm)



Descripción	Sensor Magnético	
	CASS01	CAASS01
Contacto	Normalmente abierto	
Indicador	LED Superior	
Temperatura	0 a 60 °C ~ 32 a 140 °F	
Protección	IP 67	
Rango de voltaje	5 ~ 240V AC / DC	
Rango de corriente	AC 5 ~ 50 mA, DC 5 ~ 60 mA	
Resistencia a la vibración	10 ~ 50 Hz	
Tiempo de respuesta	1 ms	
Longitud de Cable	2 Mts.	
Usar con cilindros	32 ~ 125 mm	160 y 200 mm

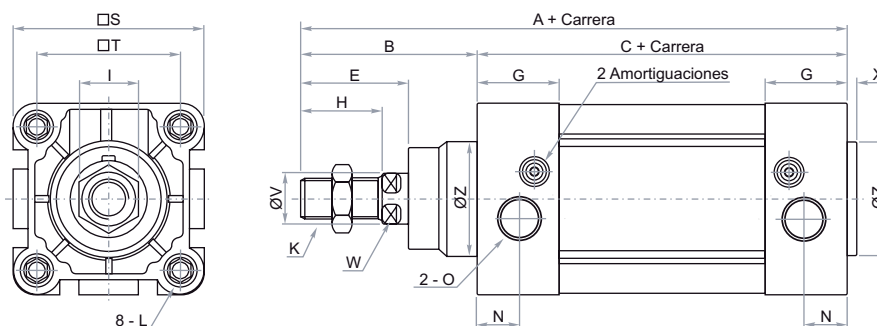

Diámetro	A	B	C	E	G	H	I	K	L
32 mm	142	48	94	29	27.5	22	17	M10 x 1.25	M6
40 mm	159	54	105	33	32	24	17	M12 x 1.25	M6
50 mm	175	69	106	42	31	32	23	M16 x 1.5	M8
63 mm	190	69	121	42	33	32	23	M16 x 1.5	M8
80 mm	214	86	128	53	33	40	26	M20 x 1.5	M10
100 mm	229	91	138	55	37	40	26	M20 x 1.5	M10
125 mm	279	119	160	74	46	54	41	M27 x 2	M12
160 mm	332	152	180	94	50	72	55	M36 x 2	M16
200 mm	347	167	180	100	50	72	55	M36 x 2	M16

Diámetro	N	O	S	T	ØV	W	X	ØZ
32 mm	13,5	1/8	46.5	32,5	12	10	3	30
40 mm	17,5	1/4	54	38	16	13	3,5	35
50 mm	14	1/4	64	46.5	20	17	3,5	40
63 mm	17	3/8	75	56,5	20	17	4	45
80 mm	16,5	3/8	93	72	25	22	4	45
100 mm	19,5	1/2	110	89	25	22	4	55
125 mm	23	1/2	134	110	32	27	4	60
160 mm	25	3/4	180	140	40	36	4	65
200 mm	25	3/4	220	175	40	36	5	75

### Cilindros Doble Vástago

Diámetro	A	C
32 mm	190	94
40 mm	213	105
50 mm	244	106
63 mm	259	121
80 mm	300	128
100 mm	320	138
125 mm	398	160
160 mm	484	180
200 mm	514	180

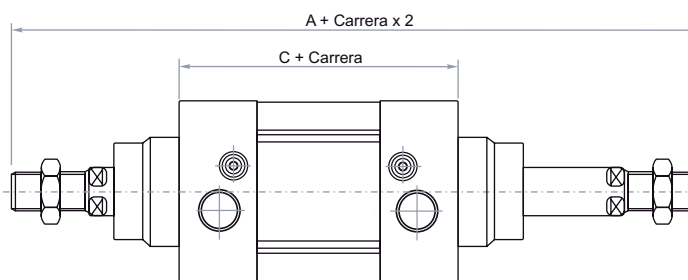

Pies

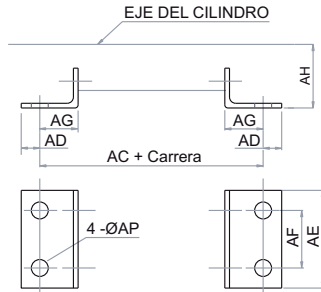

Diam.	AC	AD	AE	AF	AG	AH	ØAP
32	142	8	47	32	24	32	7
40	161	9	53	36	28	36	9
50	170	10	65	45	32	45	9
63	185	12	75	50	32	50	9
80	210	19	95	63	41	63	12,5
100	228	19	115	75	45	71	14,5
125	250	20	140	90	45	90	16,5
160	300	20	180	115	60	115	18,5
200	320	30	220	135	70	135	24

Flanche

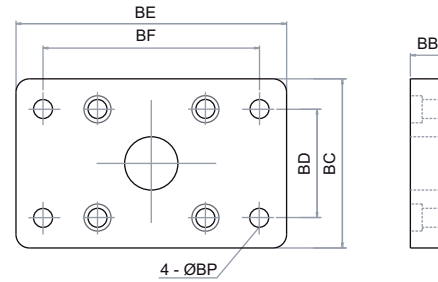

Diam.	BB	BC	BD	BE	BF	ØBP
32	10	50	32	80	64	7
40	10	55	36	90	72	9
50	12	68	45	108	90	9
63	12	78	50	120	100	9
80	16	100	63	153	126	12,5
100	16	120	75	178	150	14,5
125	20	140	90	224	180	16,5
160	20	180	115	280	230	18,5
200	25	220	135	320	270	24

Pivote Hembra

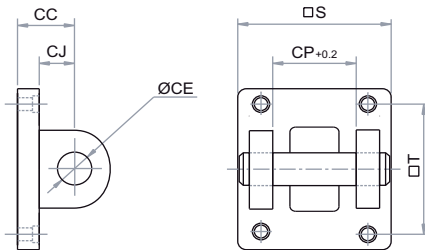

Diam.	CC	ØCE	CJ	CP	T	S
32	22	10	13	26	32,5	47
40	25	12	16	28	38	53
50	27	12	17	32	46,5	65
63	32	16	22	40	56,5	75
80	36	16	22	50	72	95
100	41	20	27	60	89	115
125	50	25	31	70	110	140
160	55	30	35,5	90	140	180
200	60	30	36	90	175	220

Pivote Macho

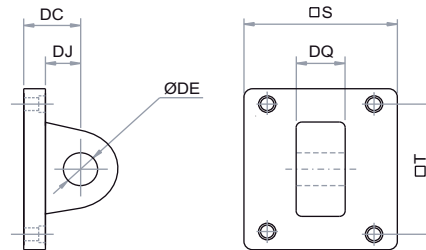

Diam.	DC	ØDE	DJ	DQ	T	S
32	22	10	13	25,8	32,5	47
40	25	12	16	27,8	38	53
50	27	12	17	31,7	46,5	65
63	32	16	22	39,7	56,5	75
80	36	16	22	49,7	72	95
100	41	20	27	59,7	89	115
125	50	25	33	69,7	110	140
160	55	30	35,5	89,7	140	180
200	60	30	37	89,7	175	220

Soporte Macho

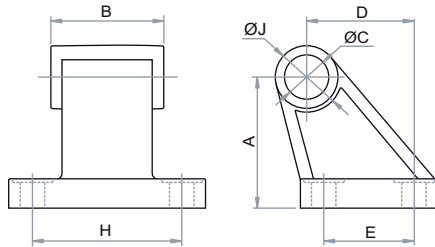

Diam.	A	B	ØC	D	E	H	ØJ
32	32	26	10	21	18	38	20
40	36	28	12	24	22	41	22
50	45	32	12	33	30	50	26
63	50	40	16	37	35	52	30
80	63	50	16	47	40	66	30
100	71	60	20	55	50	76	38
125	90	70	25	70	60	94	45
160	115	90	30	97	88	118	63
200	135	90	30	105	90	122	63

Balancín Frontal

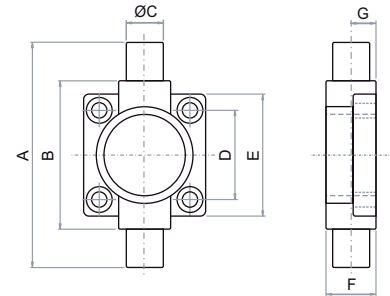

Diam.	A	B	ØC	D	E	F	G
32	74	50	12	32.5	46	19	10
40	95	63	16	38	52	21	10
50	107	75	16	46.5	64	26	12
63	130	90	20	56.5	74	28	12
80	150	110	20	72	94	31	16
100	182	132	25	89	114	35	16
125	210	160	25	110	139	43	20
160	264	200	32	140	179	56	20
200	314	250	32	175	218	64	20

Horquilla

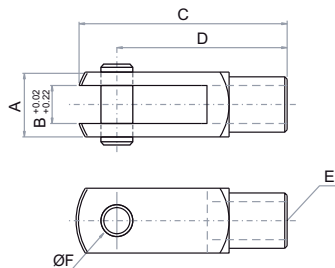

Diam.	A	B	C	D	E	F
32	19	10	52	40	M 10 x 1,25	10
40	25,4	12	62	48	M 12 x 1,25	12
50 ~ 63	32	16	83	64	M 16 x 1,5	16
80 ~ 100	44,4	20	105	80	M 20 x 1,5	20
125	54	30	151,8	110	M 27 x 2	30
160 ~ 200	70	35	195,8	144	M 36 x 2	35

Rótula

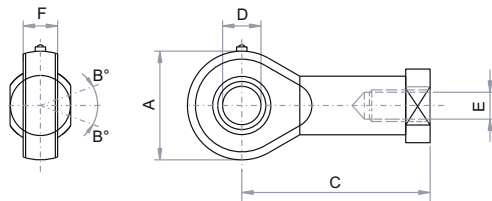

Diam.	A	B°	C	D	E	F
32	26	13°	43	10	M 10 x 1,25	11
40	32	13°	50	12	M 12 x 1,25	12
50 ~ 63	40	15°	64	16	M 16 x 1,5	15
80 ~ 100	46	15°	77	20	M 20 x 1,5	18

Autoalineador

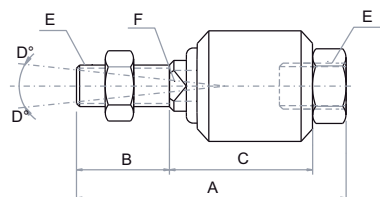

Diam.	A	B	C	D°	E	F
32	58	22	28	12°	M 10 x 1,25	10
40	58	22	29	12°	M 12 x 1,25	12
50 ~ 63	90	27	51	7°	M 16 x 1,5	17
80 ~ 100	102	29	59	10°	M 20 x 1,5	22

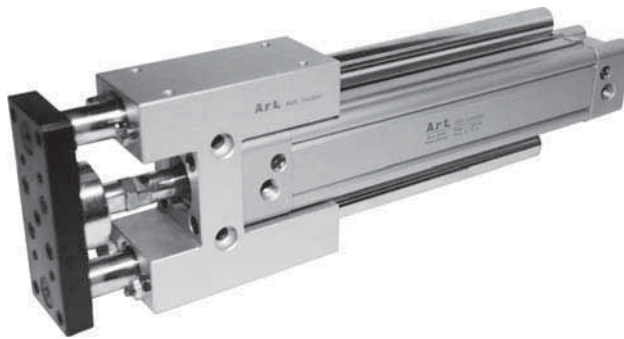

### Características

- Doble guía que garantiza el movimiento recto sin giros
- Guías sobre bujes que permiten un trabajo pesado
- El cilindro y la guía se unen por un autoalineador que evita la fricción
- Facilitan el montaje en cualquier dirección

### Datos Técnicos

Temperatura de Trabajo:  
0°C a 60°C ~ 32°F a 140°F

Velocidad:  
100 ~ 500 mm/seg

No requieren lubricación

### Materiales

Cuerpo:  
Aluminio

Guías:  
Barra de Acero

Como solicitar su guía:

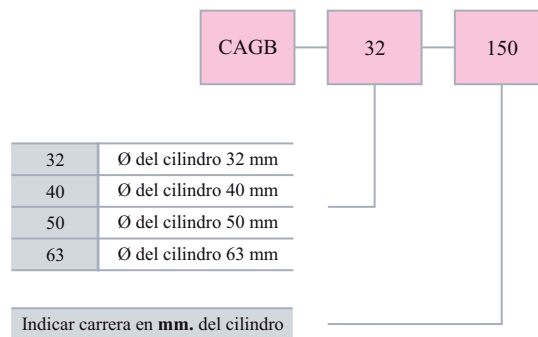

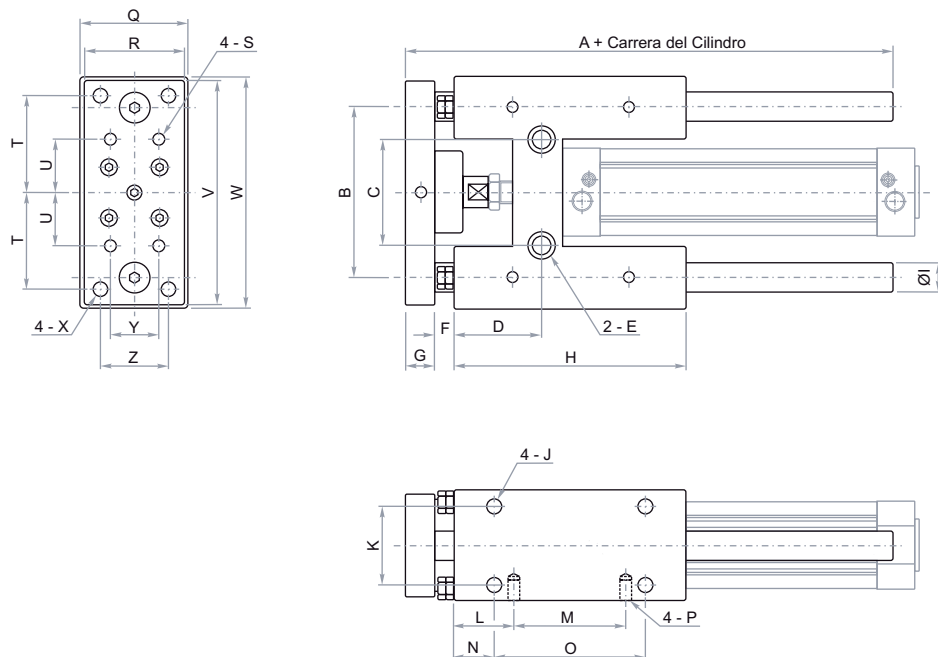

Diámetro	A	B	C	D	ØE	F	G	H	ØI
32 mm	152	88	55	45	8.5	10	15	120	20
40 mm	152	88	55	45	8.5	10	15	120	20
50 mm	200	120	80	65	10.5	10	20	160	25
63 mm	200	120	80	65	10.5	10	20	160	25

Diámetro	J	K	L	M	N	O	P	Q	R
32 mm	M6 x 1.0	40	30	60	20	80	M6 x 1.0	56	52
40 mm	M6 x 1.0	40	30	60	20	80	M6 x 1.0	56	52
50 mm	M8 x 1.25	50	40	80	30	100	M8 x 1.25	78	74
63 mm	M8 x 1.25	50	40	80	30	100	M8 x 1.25	78	74

Diámetro	S	T	U	V	W	X	Y	Z
32 mm	M6 x 1.0	50	27.5	116	120	M8 x 1.25	25	35
40 mm	M6 x 1.0	50	27.5	116	120	M8 x 1.25	25	35
50 mm	M8 x 1.25	65	40	156	160	M10 x 1.5	40	50
63 mm	M8 x 1.25	65	40	156	160	M10 x 1.5	40	50